

CUSTOMER REFERENCE DRAWING

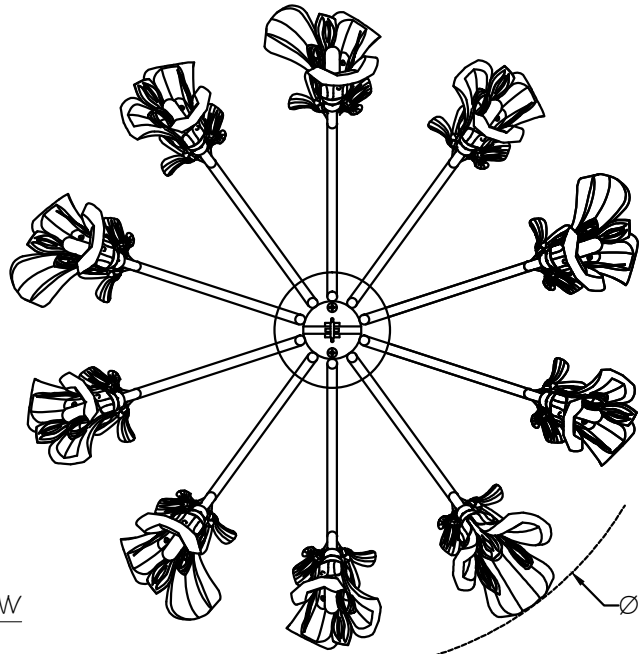

TOP VIEW

Ø35 1/2" MAX OD

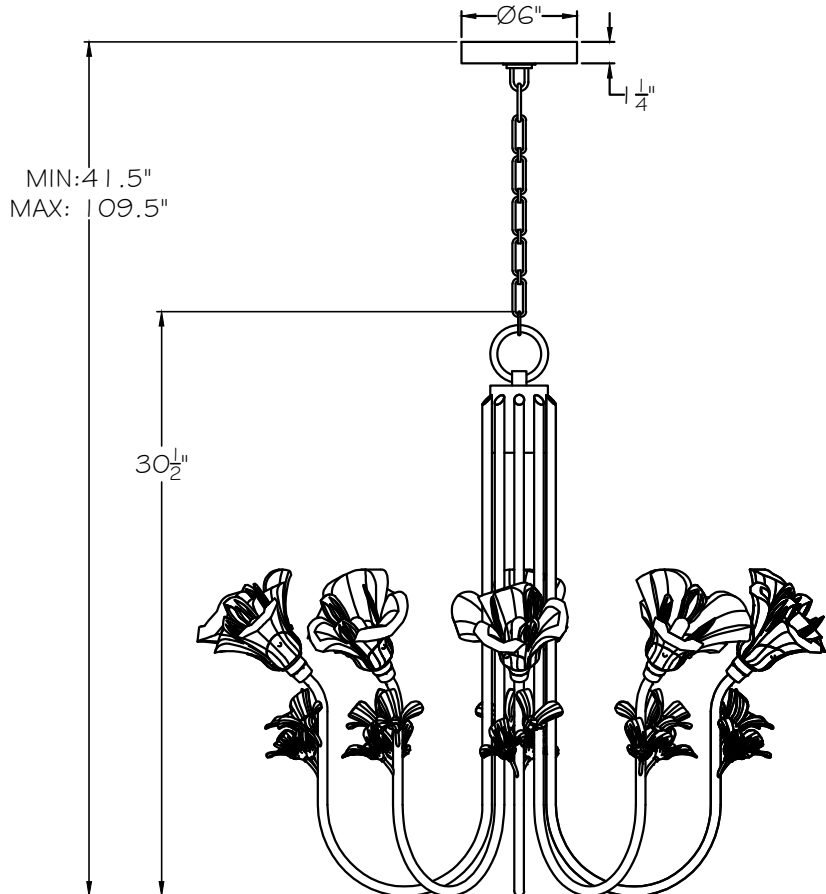

MIN: 41.5"  
MAX: 109.5"

30 1/2"

FRONT VIEW

STYLE CONFIGURATIONS:

-1ST SILVER

-2ST GOLD

-3ST WHITE GESSO



This drawing, specifications and the product depicted are the exclusive property of Fine Art Handcrafted Lighting®. In compliance with US copyright and patent requirements, notice is hereby given that this document and the product depicted shall not be copied, altered or used in any manner without the expressed written consent of Fine Art Handcrafted Lighting®.

www.finearthl.com

Tel:(305) 821-3850  
FINE ART LAMPS®

Fax:(305) 513-5736

STYLE NUMBER:

917540

DATE:

8/26/20

CRYSTAL REFERENCE DRAWING

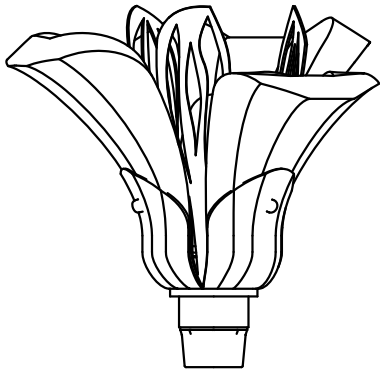

LARGE LIGHT FLOWER ASSEMBLY (X5 TOTAL)

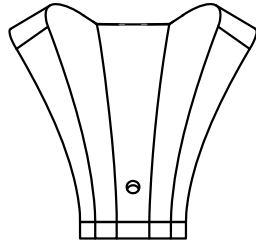

(X1 PER ASSEMBLY)  
LARGE CRYSTAL PETAL  
#00301204

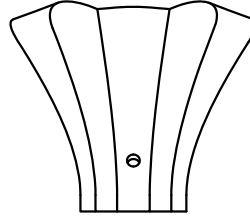

(X1 PER ASSEMBLY)  
MEDIUM CRYSTAL PETAL  
#00301205

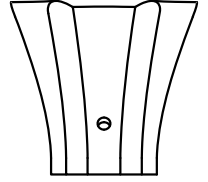

(X1 PER ASSEMBLY)  
SMALL CRYSTAL PETAL  
#00301206

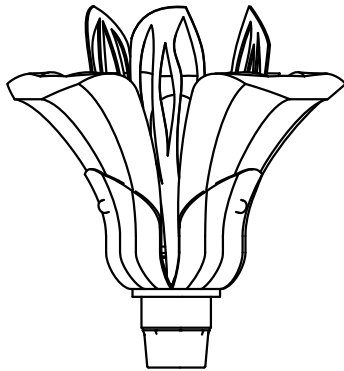

SMALL LIGHT FLOWER ASSEMBLY (X5 TOTAL)

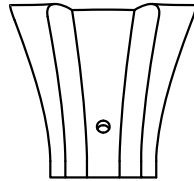

(X3 PER ASSEMBLY)  
SMALL CRYSTAL PETAL  
#00301206

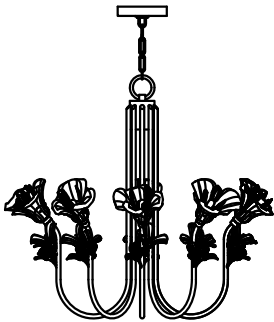

SOCKET THREADED  
COLLAR #00401212

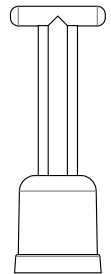

ASSEMBLY TOOL  
#00201493  
(NOT INCLUDED)

STYLE(S) #: 917540



This drawing, specifications and the product depicted are the exclusive property of Fine Art Handcrafted Lighting®. In compliance with US copyright and patent requirements, notice is hereby given that this document and the product depicted shall not be copied, altered or used in any manner without the expressed written consent of Fine Art Handcrafted Lighting®.

www.finearthl.com

Tel:(305) 821-3850  
FINE ART LAMPS®

Fax:(305) 513-5736

INSTRUCTION #:

00791444

SHEET

1 / 1